

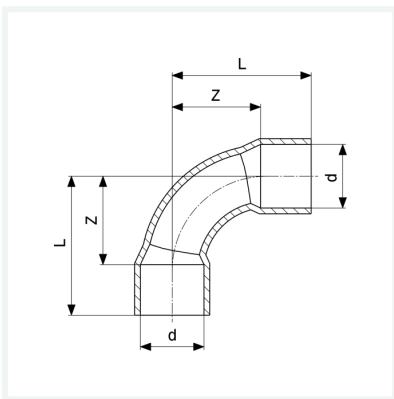

Bogen 90°
- Lötanschluss
Modell 95002A

Artikel 100 063



Eigenschaften

Gütesicherung Cu	Cu	✓
Rohraußendurchmesser	d	22
Z-Maß	Z	26 mm
Länge	L	42 mm
Gewicht	47,75 g	
Volumen	69,3 cm ³	
Werkstoff	Kupfer	